

# AL SERIES PUMPS



All Ampco PD pumps include  
a stainless steel gear case



# AL Series Rotary Lobe Positive Displacement Pumps

Ease of maintenance, CIP performance, uptime reliability, and economical pricing are key characteristics of Ampco's AL Series of rotary lobe positive displacement pumps, making this series a favorite of maintenance departments and plant managers. Every new positive displacement pump Ampco manufactures is supplied with a 304 stainless steel gear case, making these pumps popular with inspectors, as well.

The AL Series features a unique front-loading seal design to provide easier cleaning and reduced maintenance time. Rotors and seals can be effortlessly accessed by removing the front cover while connections remain in place.

STANDARD DESIGN FEATURES	OPTIONAL DESIGN FEATURES
304 Stainless steel gear case	
Single mechanical seal (silcar vs. silcar)	O-ring seal Double o-ring seal Double lip seal Triple lip seal Mechanical seal with seal flush Double mechanical seal
316L stainless steel pump construction	Alloy 88 or Nitronic 60 rotors available with non-galling appeal
Tri-clamp connection	NPT, DIN, ANSI flange, and other connections available
Bi-wing rotors	Single- tri-, and multi-lobe rotors Heating and cooling jackets Relief cover
32RA (0.8µm) finish	16RA (0.4µm) finish



Shown with pressure relief cover

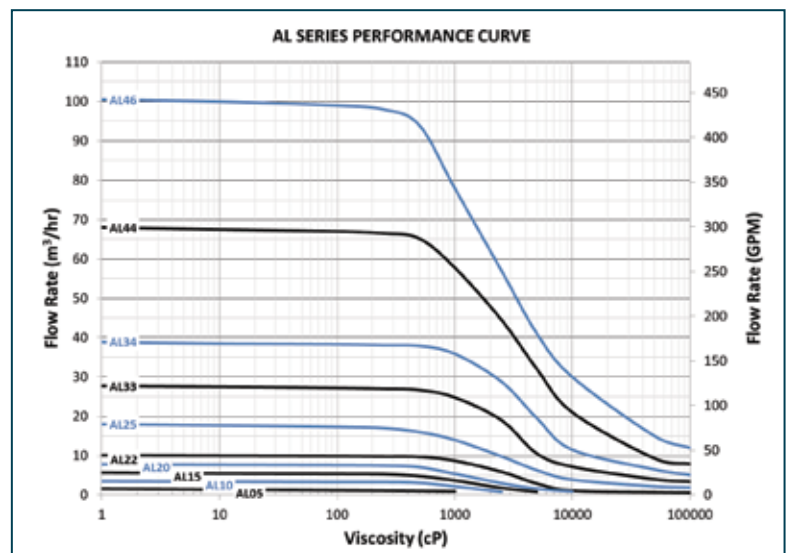
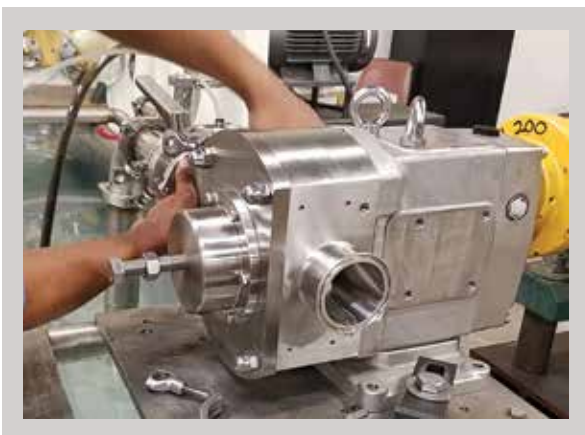



## Applications

The AL Series is well suited for a variety of applications including food, dairy, beverage, and pharmaceutical applications. These pumps accommodate viscosities ranging from 1 to 1,000,000 centipoise. Self-priming capabilities up to 12' / 3.7m and flow rates up to 440 GPM / 100 m<sup>3</sup>/hr make this a versatile, yet economical, pump for a variety of processing applications.

Shown with optional cover  
and rotor heating jackets

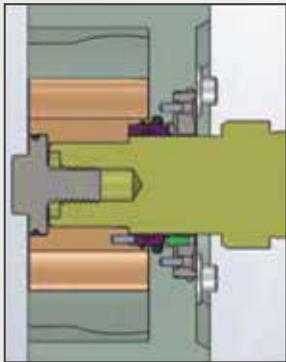

Single Mechanical Seal

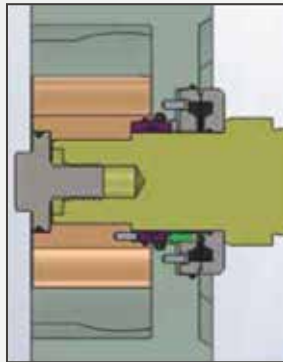

Double Mechanical Seal

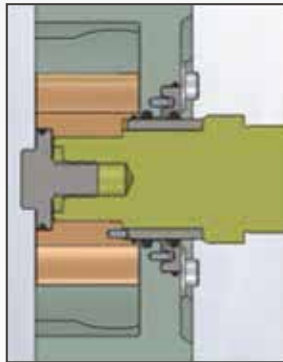

Double-O-Ring Seal

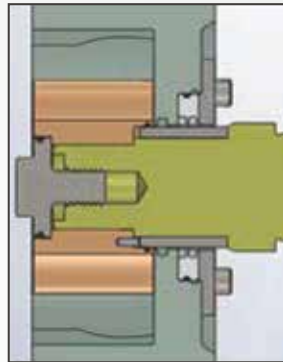

Lip Seal

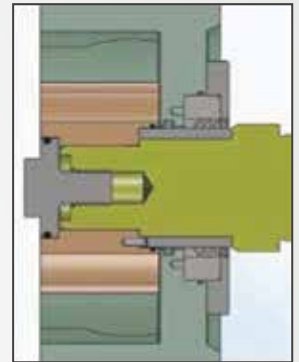

Triple Lip Seal

MODEL NUMBER	Displacement		Standard Connection Size		Max Differential Pressure		Max Speed
	Gallons/100 Rev	Liters/Rev	IN	MM	PSI	BAR	RPM
AL05-002-20	0.53	0.02	1.00	25	290	20	1000
AL10-005-20	1.32	0.05	1.00	25	290	20	1000
AL15-012-12	3.17	0.12	1.50	40	175	12	800
AL20-021-08	5.55	0.21	2.00	50	115	8	800
AL22-040-12	10.56	0.40	2.00	50	175	12	700
AL25-062-08	16.37	0.62	2.50	65	115	8	700
AL33-120-12	26.90	1.02	3.00	80	175	12	600
AL34-144-08	37.98	1.44	4.00	100	115	8	600
AL44-227-12	59.88	2.27	4.00	100	175	12	500
AL46-334-08	88.10	3.34	6.00	150	115	8	500



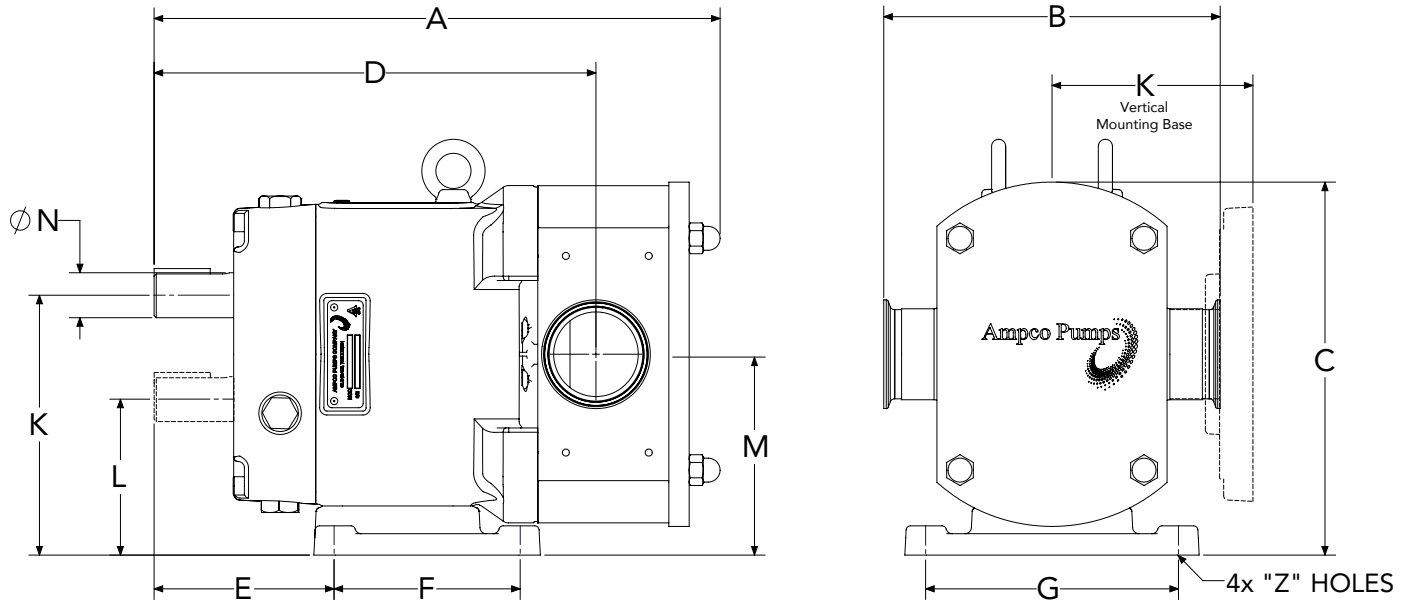

KEY DETAILS: X: LENGTH Y: WIDTH

DIMENSIONS

KEY DETAILS

MODEL NUMBER	A		C		D		E		F		G		K		L		M		N		X		Y		Z		WEIGHT	
	MM	IN	MM	IN	MM	IN	MM	IN	MM	IN	MM	IN	MM	IN	MM	IN	MM	IN	MM	IN	MM	IN	MM	IN	MM	IN	kg	lbs
AL05-002-20	255	10.0	200	7.9	218	8.6	96	3.78	84	3.31	134	5.28	141	5.55	77	3.03	109	4.29	22	0.87	30	1.18	6	0.24	8.8	0.35	12	27
AL10-005-20	255	10.0	200	7.9	218	8.6	96	3.78	84	3.31	134	5.28	141	5.55	77	3.03	109	4.29	22	0.87	30	1.18	6	0.24	8.8	0.35	12	27
AL15-012-12	264	10.4	200	7.9	222	8.7	96	3.78	84	3.31	134	5.28	141	5.55	77	3.03	109	4.29	22	0.87	30	1.18	6	0.24	8.8	0.35	19	42
AL20-021-08	284	11.2	200	7.9	230	9.1	96	3.78	84	3.31	134	5.28	141	5.55	77	3.03	109	4.29	22	0.87	30	1.18	6	0.24	8.8	0.35	23	51
AL22-040-12	386	15.2	265	10.4	305	12.0	129	5.08	132	5.20	180	7.09	185	7.28	101	3.98	143	5.63	32	1.26	50	1.97	10	0.39	11	0.43	45	100
AL25-062-08	406	16.0	265	10.4	315	12.4	129	5.08	132	5.20	180	7.09	185	7.28	101	3.98	143	5.63	32	1.26	50	1.97	10	0.39	11	0.43	51	113
AL33-120-12	533	21.0	348	13.7	390	15.4	159	6.26	160	6.30	242	9.53	244	9.61	129	5.08	186	7.32	45	1.77	60	2.36	14	0.55	13	0.51	91	201
AL34-144-08	546	21.5	348	13.7	402	15.8	159	6.26	160	6.30	242	9.53	244	9.61	129	5.08	186	7.32	45	1.77	60	2.36	14	0.55	13	0.51	103	228
AL44-227-12	622	24.5	456	18.0	506	19.9	197	7.76	210	8.27	320	12.60	323	12.72	169	6.65	246	9.69	55	2.17	63	2.48	16	0.63	15	0.59	180	397
AL46-334-08	658	25.9	456	18.0	525	20.7	197	7.76	210	8.27	320	12.60	323	12.72	169	6.65	246	9.69	55	2.17	63	2.48	16	0.63	15	0.59	210	463

AL-SERIES 'B' DIMENSION

MODEL NUMBER	PORT SIZE		FLANGE		ISO		BS		DIN		SMS	
	MM	(IN)	MM	(IN)	MM	(IN)	MM	(IN)	MM	(IN)	MM	(IN)
AL5-002-20	25.4	1	212	8.3	192	7.6	204	8.0	212	8.3	192	7.6
AL10-005-20	25.4	1	212	8.3	192	7.6	204	8.0	212	8.3	192	7.6
AL15-012-12	38	1.5	212	8.3	196	7.7	204	8.0	212	8.3	192	7.6
AL20-021-08	50.8	2	212	8.3	196	7.7	204	8.0	212	8.3	192	7.6
AL22-040-12	63.5	2	248	9.8	232	9.1	240	9.4	248	9.8	236	9.3
AL25-062-08	63.5	2.5	258	10.2	240	9.4	240	9.4	258	10.2	236	9.3
AL33-120-12	76.2	3	322	12.7	298	11.7	294	11.6	322	12.7	290	11.4
AL34-144-08	101.6	4	350	13.8	298	11.7	294	11.6	350	13.8	290	11.4
AL44-227-12	101.6	4	432	17.0	380	15.0	376	14.8	432	17.0	372	14.6
AL46-334-08	152.4	6	432	17.0	413	16.3	376	14.8	432	17.0		

Visit [www.amcopumps.com](http://www.amcopumps.com) for individual pump curves and dimensional drawings.

REV 11.20



2045 W. Mill Road  
Glendale, WI 53209  
Phone: 800.737.8671  
[www.amcopumps.com](http://www.amcopumps.com)

Gewerbepark West II 7  
76863 Herxheim Germany  
Phone: +49 7276 5058515  
[info@amcopumps.de](mailto:info@amcopumps.de)

